

GROUND ENGAGING TOOLS



DEEPSOUTH
HEAVY EQUIPMENT PARTS

601-325-0724

INDEX

Caterpillar® Style Teeth (J200, J225, J250)	Page 2
Caterpillar® Style Teeth (J300, J350, J400)	Page 3
Caterpillar® Style Teeth (J450, J550)	Page 4
Caterpillar® Style Teeth (J600, J700, J800)	Page 5
Caterpillar® Top Pin Style Teeth	Page 5
Caterpillar® Style Half Arrow Segments	Page 5
Caterpillar® Style Modulok® and Hensley® Style Vertical Edge Protectors	Page 5
Caterpillar® Style Ripper Teeth, Protectors and Shanks	Page 6
Caterpillar® Style Adapters	Page 7-9
Caterpillar®, Galion®, and Champion® Style Scarifier Teeth and Shanks for Graders	Page 9
Caterpillar® and John Deere® Style Scraper Parts	Page 10-11
Caterpillar® Style Compactor Feet, Cleaner Bars, and Stands	Page 12
Caterpillar® D6C/D, D8K, D9L, D10N and D11N Style Heavy Duty Cast End Bits	Page 12
Caterpillar®, Hensley®, John Deere®, Esco® and Universal Style Sidecutters	Page 12
Hensley® Style Parabolic Teeth	Page 13
Hensley® Style Parabolic Adapters	Page 14
Hensley® Style '5' Series Teeth	Page 14
Chocky Bars and Wear Buttons (Laminite®, White Iron)	Page 15
Esco® Style Helilok®/Vertalok® Teeth	Page 16
Esco® Style Conical® Teeth	Page 16
Esco® and Kelly® Style Ripper Teeth	Page 16
H&L® Style Teeth & Adapters	Page 17
John Deere® Style Teeth & Adapters	Page 18
Hendrix® Style Teeth & Dredge Parts	Page 18
Bobcat® Style Tooth and Adapter	Page 19
Ford® Style Tooth & Adapter	Page 19
ADCO® Style Teeth and Adapter Nose	Page 19
Komatsu®, Fiat®, and Hyundai® Style Teeth	Page 20
Flying Tiger® & Wing Tip Style Teeth for CAT® and H&L®	Page 21
Plow Bolts and Nuts	Page 22

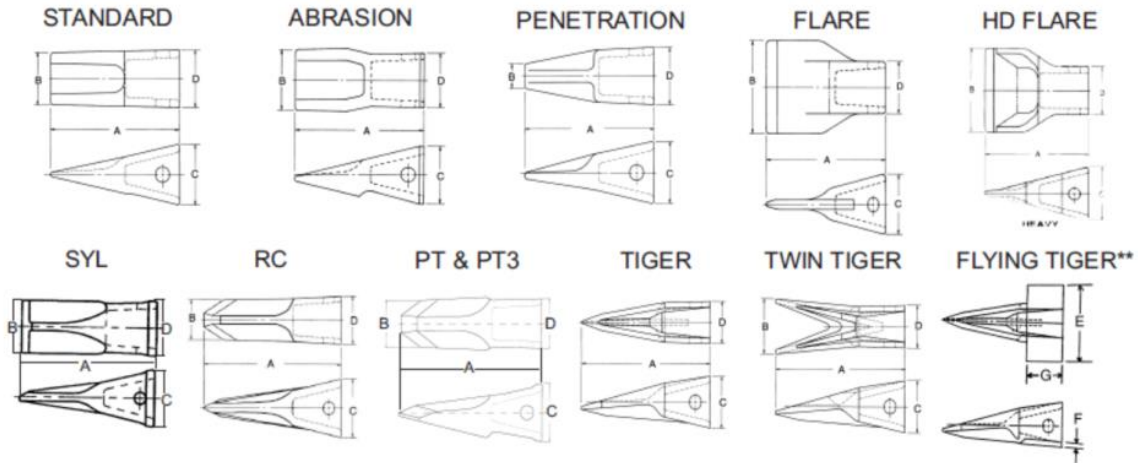

**See page 21 for E, F, & G
Use Tiger for A, B, & D.

CAT® SKID STEER

CAT® #	Style	Weight lbs.	FH Screw	Lock Nut
1324720	Unitooth B/O	4.4	1592953	8T4778

CAT® J200: 416, 426, 428, 436, 910, 931, 935, 307

Part #	Style	Weight lbs.	A	B	C	D	Pin	Lock*
1U3201	Short	2.7	5 1/4	2	2 7/16	2 1/4	8E6208	8E6209
1U3202	Long	3.1	5 11/16	1 15/16	2 1/2	2 3/8	8E6208	8E6209
1U3202F	Flare	2.8	5	4 3/8	2 5/16	2 3/8	8E6208	8E6209
1U3202FG	Forged Long	3.1	5	4 3/8	2 5/16	2 3/8	8E6208	8E6209
1U3202FT	Flying Tiger	3	6 1/2		2 3/8	2 1/4	8E6208	8E6209
1U3202T	Tiger	2.4	6 1/2		2 3/8	2 1/4	8E6208	8E6209
1U3202WT	Twin Tiger	3	6 1/2	3	2 3/8	2 1/4	8E6208	8E6209
6Y6335	Unitooth B/O	5.8	BOLT	4F3656	NUT	5P8362		

*All Steel Lock is 4T0001

CAT® J225: 446 and 933

Part #	Style	Weight lbs.	A	B	C	D	Pin	Lock*
6Y3222	Long	4.2	6 5/8	2 1/4	3 3/16	2 9/16	6Y3228	8E6259
6Y3222F	HD Flare	5.9	5 3/4	4 5/8	3 3/16	2 5/8	6Y3228	8E6259
6Y3222FT	Flying Tiger	5.5	7 7/8		3 3/16	2 19/32	6Y3228	8E6259

*All Steel Lock is 3G9609
Spiral Lock is 149-5733

CAT® J250: 916 THRU 930, 936, 941, 943, 951, 953, 205 THRU 214, 225, 229, 311, 312, 320

Part #	Style	Weight lbs.	A	B	C	D	Pin	Lock*
1U3251	Short	4.7	6 3/8	2 9/16	3 1/4	2 7/8	8E6258	8E6259
1U3252	Long	6.6	7 11/16	2 7/16	3 7/16	2 13/16	8E6258	8E6259
1U3252AP	All Purpose	6.2	7 1/2	2 1/2	3 5/16	2 7/8	8E6258	8E6259
1U3252FG	Forged Long	6.6	7 1/2	2 1/2	3 1/3	3	8E6258	8E6259
1U3252FT	Flying Tiger	9.0	8		3 15/16	2 7/8	8E6258	8E6259
1U3252P	Excavator Tooth	5.2	7 1/2	2 1/2	3 1/4	2 7/8	8E6258	8E6259
1U3252RC	Rock Chisel	8.6	8 1/2	2 3/8	3 9/16	2 15/16	8E6258	8E6259
1U3252T	Tiger	7.5	8		3 15/16	2 7/8	8E6258	8E6259
1U3252WT	Twin Tiger	7.5	8	3 1/2	3 5/16	2 7/8	8E6258	8E6259
3G8250	Flare	8.5	7 3/4	4 9/16	3 1/2	2 13/16	8E6258	8E6259
4T2253PT	ABR/Penetration	11.5	9 3/16	2 5/8	3 11/16	3	8E6258	8E6259
9J4253	Abrasion	7.0	7 1/2	3	3 1/4	3	8E6258	8E6259
9J4259	Penetration	5.2	7 11/16	1 1/4	3 3/8	2 15/16	8E6258	8E6259
9N4252	HD Long	8.6	7 7/8	2 3/8	3 11/16	3	8E6258	8E6259
9N4253	HD Abrasion	9.7	7 7/16	3 1/16	3 5/16	3	8E6258	8E6259

CAT® J300: 950, 953B THRU 966, E180, 215, 219, 235, 205 THRU 214, 315, 320, 322

Part #	Style	Weight lbs.	A	B	C	D	Pin	Lock*
1U3301	Short	7.9	7 7/16	3	3 15/16	3 7/16	9J2308	8E6259
1U3302	Long	9.5	8 3/8	3 1/8	4	3 3/8	9J2308	8E6259
1U3302FG	Forged Long	9.5	8 7/16	3 1/16	4 1/16	3 7/16	9J2308	8E6259
1U3302FT	Flying Tiger	12.0	9 1/2		4 1/8	4 1/2	9J2308	8E6259
1U3302P	Excavator Tooth	8.4	8 5/8	2 7/8	3 15/16	3 5/16	9J2308	8E6259
1U3302RC	Rock Chisel	12.4	9 3/4	2 7/8	4 3/16	3 7/16	9J2308	8E6259
1U3302SYL	Excavator Long	9.7	9	3 11/16	4	3 5/8	9J2308	8E6259
1U3302TL	Tiger Long	9.3	9 1/2		4 1/8	4 1/2	9J2308	8E6259
1U3302WTL	Twin Tiger Long	10.7	9 1/2	4 3/16	4 3/16	4 7/16	9J2308	8E6259
4T1300	Flare	11.5	8 1/2	6	3 7/8	3 3/8	9J2308	8E6259
4T2303	Abrasion	11.0	8 5/8	4	3 7/8	3 9/16	9J2308	8E6259
4T2303PT	ABR/Penetration	16.8	10 1/4	3 5/16	4 5/16	3 1/2	9J2308	8E6259
9J4309	Penetration	8.6	8 11/16	1 9/16	4 1/16	3 1/2	9J2308	8E6259
9N4302	HD Long	12.3	8 11/16	2 3/4	4 1/8	4 1/2	9J2308	8E6259
9N4303	HD Abrasion	14.8	8 7/8	4 1/4	4	3 3/8	9J2308	8E6259

*All Steel Lock is 3G9609
Spiral Lock is 149-5733

CAT® J350: 966B, 977, 980, E180, E240, 213B, 214B, 215 THRU 229, 320, 322, 325, 330

Part #	Style	Weight lbs.	A	B	C	D	Pin	Lock*
1U3351	Short	9.9	7 15/16	3 1/2	4 1/8	3 13/16	8E6358	8E6359
1U3352	Long	14.1	9 1/2	3 11/16	4 1/4	4	8E6358	8E6359
1U3352FG	Forged Long	15.9	9 1/2	3 11/16	4 1/2	4 1/16	8E6358	8E6359
1U3352FT	Flying Tiger	19.8	11		4 7/16	4 1/8	8E6358	8E6359
1U3352P	Excavator Tooth	11.0	9 1/4	3 5/8	4 3/16	3 3/4	8E6358	8E6359
1U3352RC	Rock Chisel	17.9	11	3 3/8	4 7/16	4	8E6358	8E6359
1U3352SYL	Excavator Long	19.2	10 3/8	4 3/16	4 9/16	3 15/16	8E6358	8E6359
1U3352T	Tiger	16.5	11 3/8		4 3/8	4 3/16	8E6358	8E6359
1U3352TL	Tiger Long	13.4	11 1/4		4 5/16	4	8E6358	8E6359
1U3352WT	Twin Tiger	16.7	10 3/4	4 3/4	4 1/2	4 1/16	8E6358	8E6359
1U3352WTL	Twin Tiger Long	15.1	11 1/4	4 3/4	4 5/16	4	8E6358	8E6359
4T2353	Abrasion	16.8	9 1/4	4 5/16	4 1/4	3 7/8	8E6358	8E6359
4T2353PT	ABR/Penetration	21.6	11 7/16	3 13/16	4 7/16	4	8E6358	8E6359
8J3350	Flare	16.7	9 1/2	7	4 1/2	4	8E6358	8E6359
9J4359	Penetration	12.1	9 5/8	1 7/8	4 7/16	4	8E6358	8E6359
9N4352	HD Long	18.7	10 1/16	3 7/16	4 5/8	3 15/16	8E6358	8E6359
9N4353	HD Abrasion	23.9	10	4 13/16	4 9/16	4	8E6358	8E6359

*All Steel Lock is 3G9549
Spring Lock is 114-0359

CAT® J400: 980G, 322, 325, 330

Part #	Style	Weight lbs.	A	B	C	D	Pin	Lock*
6Y7409	Penetration	18.5	10 1/2	2 1/8	5 1/8	4 5/8	7T3408	8E8409
7T3402	Long	18.7	10 5/16	4 1/16	4 7/8	4 9/16	7T3408	8E8409
7T3402F	HD Flare	25.6	10 5/16	8 1/4	4 15/16	4 11/16	7T3408	8E8409
7T3402FT	Wing Tip	26.5	12 3/8		5 5/16	4 7/8	7T3408	8E8409
7T3402PT	ABR/Penetration	30.9	12 5/8	4 1/4	4 7/8	4 5/8	7T3408	8E8409
7T3402RC	Rock Chisel	26.0	12 1/8	3 7/8	5 3/32	4 5/8	7T3408	8E8409
7T3402TL	Tiger Long	21.6	12 13/16		5 1/4	4 11/16	7T3408	8E8409
				5 7/16	5 3/16	4 5/8	7T3408	8E8409
8E4402SYL	Excavator Long	28.7	12	4 3/4	5 1/4	4 7/8	7T3408	8E8409
8E4402	HD Long	25.0	11 1/8	4	5 1/4	4 7/8	7T3408	8E8409

*Spring Lock is 116-7409

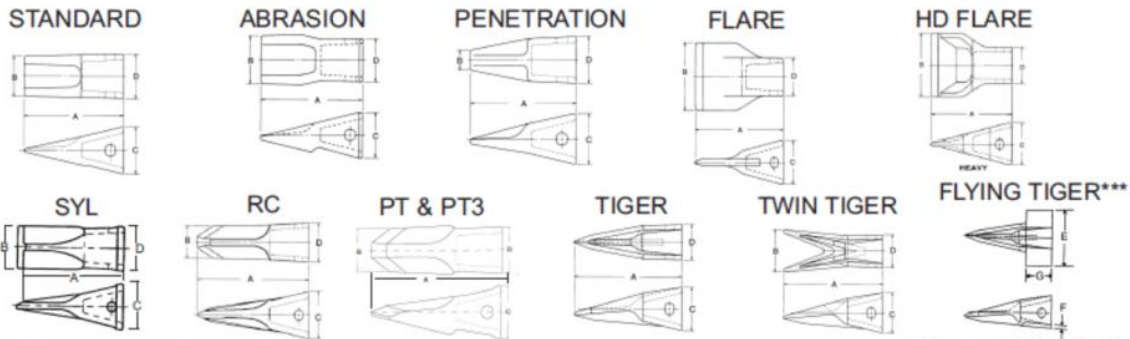

CAT® J450/460: 983, 988, 988B, 225, 229, E300, 235, 325, 330, 345, 350

***See page 21 for E, F, & G

Part #	Style	Weight lbs.	A	B	C	D	Pin	Lock**
138-6451	HD ABR/Penetration	48.5	14	5	5 15/16	5 5/8	8E0468	8E8469
1U3452F	HD Flare	34.5	11 1/4	9	5 3/16	5 1/8	6Y2527*	8E6359
1U3452FT	Flying Tiger	28.7	13 5/16		5 5/16	5 3/16	6Y2527*	8E6359
1U3452RC	Rock Chisel	31.4	13	4 1/4	5 3/8	5 3/16	6Y2527*	8E6359
1U3452TL	Tiger Long	29.5	14 1/16		5 3/8	5 1/4	6Y2527*	8E6359
1U3452WT	Twin Tiger	24.9	12	15 11/16	5	5 1/8	6Y2527*	8E6359
1U3452WTL	Twin Tiger Long	33.1	14 1/16	6 7/16	5 3/8	5 1/4	6Y2527*	8E6359
9N4452	HD Long	36.4	12 7/16	4 5/8	5 1/2	5 1/4	6Y2527*	8E6359
9N4453	HD Abrasion	46.7	12 5/16	6 1/2	5 5/8	5 3/16	6Y2527*	8E6359
9W1453	Abrasion	34.0	11 5/8	5 3/8	5 5/16	5	6Y2527*	8E6359
9W1453PT	ABR/Penetration	49.6	13 15/16	5 1/8	5 13/16	5 3/8	8E0468	8E8469
9W1453PT3	HD ABR/Penetration	53.5	14 1/2	5 1/8	6	5 1/2	8E0468	8E8469
9W1453RP3	HD ABR/Penetration	52.3	14 1/4	4 7/8	5 11/16	5 1/4	8E0468	8E8469
9W8451	Short	25.4	10 1/2	4 5/8	4 15/16	5 3/16	6Y2527*	8E6359
9W8452	Long	27.2	11 1/2	4 5/16	5	4 15/16	6Y2527*	8E6359
9W8452FG	Forged Long	27.2	11 5/8	4 13/16	4 9/16	4 1/4	6Y2527*	8E6359
9W8452SYL	Excavator Long	29.8	12 11/16	5 3/16	5 9/16	5 3/16	6Y2527*	8E6359
9W8452T	Tiger	25.1	12 7/8		5 5/16	5 1/8	6Y2527*	8E6359
9W8459	Penetration	24.9	11 9/16	2 1/8	5 3/8	4 15/16	6Y2527*	8E6359

* If adaptor is J460 with larger pin hole use 8E0468 pin and 8E8469 lock.

**All Steel Lock is 3G9549 Spring Lock for 6Y2527 is 114-0359
Spring Lock for 8E0468 is 107-3469

CAT® J550: 988G, 992, 235, 245, 345, 350, 375

Part #	Style	Weight lbs.	A	B	C	D	Pin	Lock*
138-6552	HD ABR/Penetration	68.1	15 1/4	5 1/2	6 1/2	6 5/16	6Y8558	8E5559
1U3552F	HD Flare	65.0	13 3/4	11	6 1/8	6 5/16	6Y8558	8E5559
1U3552FG	Forged Long	41.0	13 3/16	5 5/8	5 3/4	6	6Y8558	8E5559
1U3552FT	Flying Tiger	54.2	15 1/8		6 3/8	6 5/16	6Y8558	8E5559
1U3552RC	Rock Chisel	50.0	15	5 1/8	6 1/8	6 1/4	6Y8558	8E5559
1U3552SYLFG	SYL Forged	41.4	14	5	6 1/8	6 1/4	6Y8558	8E5559
1U3552TL	Tiger Long	36.6	15		5 3/4	6 1/8	6Y8558	8E5559
1U3552WT	Twin Tiger	35.3	13 1/4	6 11/16	5 3/8	6	6Y8558	8E5559
1U3552WTL	Twin Tiger Long	38.4	15	7 1/4	5 3/4	6 1/8	6Y8558	8E5559
6Y2553	Abrasion	68.8	13 9/16	7 1/2	6 1/4	6 1/4	6Y8558	8E5559
9N4552	HD Long	54.2	14 9/16	5 1/2	6 3/8	6 1/4	6Y8558	8E5559
9W1553PT	ABR/Penetration	60.6	14 3/16	5 1/2	6 1/16	6 1/4	6Y8558	8E5559
9W1553RP3	HD ABR/Penetration	68.5	15 1/4	5 5/32	6 1/4	6 1/4	6Y8558	8E5559
9W8551	Short	39.8	11 5/16	5 9/16	5 3/4	6	6Y8558	8E5559
9W8552	Long	41.4	13 3/16	5 5/8	5 3/4	6 1/16	6Y8558	8E5559
9W8552SYL	Excavator Long	46.7	14 3/8	6 1/8	6	6 3/16	6Y8558	8E5559
9W8552T	Tiger	46.7	15 1/2		6 3/8	6 5/16	6Y8558	8E5559
9W8559	Penetration	32.2	13 1/4	2 9/16	5 9/16	5 15/16	6Y8558	8E5559

*All Steel Lock is 3G9559
Spring Lock is 107-8559

CAT® J600: 992, 375

Part #	Style	Weight lbs.	A	B	C	D	Pin	Lock*
135-9600	HD ABR/ Penetration	124.4	17 3/4	6 1/4	7 1/2	7 1/2	6I6608	6I6609
616602	Long	74.5	15	6 1/2	7 5/16	7 3/4	6I6608	6I6609
616602TL	Tiger Long	74.7	18		7 1/4	7 3/4	6I6608	6I6609
616602WTL	Twin Tiger Long	79.8	18 1/4	9 3/16	7 1/4	7 13/16	6I6608	6I6609
616603PT	ABR/Penetration	128.3	18 1/2	6 3/8	7 1/4	7 13/16	6I6608	6I6609
717609	Penetration	58.4	15 1/2	3 3/8	7 1/4	7 1/2	6I6608	6I6609
7Y0602	HD Long	92.0	16	6 1/2	7 1/2	7 1/2	6I6608	6I6609

*Spring Lock is 113-9609

CAT® J700: 992G, 994, 375 (VMX bucket)

Part #	Style	Weight lbs.	A	B	C	D	Pin	Lock*
135-9700	HD ABR/Penetration	142.1	20	7	8 1/2	8	4T4708	4T4707
4T4702	Long	82.0	16 1/2	7 1/8	8 3/8	7 7/8	4T4708	4T4707
4T4703	Abrasion	108.0	16 7/16	9	8 1/2	7 15/16	4T4708	4T4707
4T4703PT	ABR/Penetration	123.5	19 3/4	3	8 1/2	8 1/4	4T4708	4T4707
4T4703RP3	HD ABR/Penetration	125.0	19 1/2	7	8 1/8	7 7/8	4T4708	4T4707
4T4709	Penetration	86.0	12 1/2	3 1/4	8 1/2	8 1/4	4T4708	4T4707

*Spring Lock is 113-4709

CAT® J800: 994

Part #	Style	Weight lbs.	A	B	C	D	Pin	Lock
618803	Abrasion	226.0	18 1/2	11 1/2	9 1/2	9 5/8	134-1808	134-1809

CAT® TOP PIN CONICAL STYLE TEETH (For adapter, see CAT/ESCO® STYLE TOP PIN WELD ON ADAPTERS page 7.)

Part #	Style	Weight lbs.	A	B	C	D	Pin	Lock
4K0034	P18	4.6	7 5/16	2 5/8	2 11/16	2 5/8	4K0043	4K0041
4K6148		7.1	7 5/8	2 15/16	3 1/16		4K0032	4K0008
4K6936	P23	3.1	6 7/8	2 1/8	2 11/16	2 1/8	4K0043	4K0041
5K2924	P23	2.5	6 1/8	3	2 3/4	2 9/16	4K0043	4K0041
5K2925	P18	3.2	5 1/8	3 1/16	2 1/16	2 9/16	4K0043	4K0041
5K2926		5.9	6 1/16	3 3/8	3 1/8	3 5/16	4K0043	4K0041

CAT® STYLE HALF ARROW SEGMENTS

Part #	Type	Machine	Quantity	Weight lbs.	Thickness	Bolt	Nut	Qty
1U0593NR	Center	966, 966B, 966C	3	230.0	2 7/8	5P8823	3K9770	12
1U0762NR	Center	980, 980B	3	274.0	3 1/8	5P8823	3K9770	12
3G6395RNR	Right	966	1	69.0	2 7/8	5P8823	3K9770	3
3G6395LNR	Left	966	1	69.0	2 7/8	5P8823	3K9770	3
9W5730NR	Left	988B	3	68.0	2 3/4	5P8823	3K9970	3
9W5734NR	Center	988B	1	64.0	2 3/4	5P8823	3K9970	3
9W5737NR	Right	988B	3	68.0	2 3/4	5P8823	3K9970	3
101-9435	Center	988F	3	83.0	2 7/8	5P8823	3K9970	3
101-9436	Right	988F	2	86.0	2 7/8	5P8823	3K9970	3
101-9437	Left	988F	2	86.0	2 7/8	5P8823	3K9970	3
109-2675*	Center	988G, *990, 992	1	250.2	5 1/8	5P8823	3K9970	4
109-2676*	Right	988G, *990, 992	3	268.9	5 1/8	5P8823	3K9970	4
109-2677*	Left	988G, *990, 992	3	268.9	5 1/8	5P8823	3K9970	4
217-4726	Right/Left	980B, 980G	2	82.0	3 1/8	5P8823	3K9770	3
217-4727	Center	980G	3	227.0	3 1/8	5P8823	3K9770	12

*For 990 use 2 of each type

CAT® STYLE MODULOK® AND HENSLEY® VERTICAL EDGE PROTECTORS

Part #	Machine	Quantity	Weight lbs.	Pin	Lock/Plug	Quantity		
1U0740	992	2	49.0	1U0739	8E5559	4		
9J9600	988B	2	38.0	9J8842	6Y9459	4		
VS450*	6-8 Yards	2	42.5	EMP-003	EMI-004	4		
VS500*	9-15 Yards	2	66.0	VS272P	EMI-004	4		

*VS450/550 Optional Weldments - VSM100WN (1.0"), VSM150WN (1.5"), VSM175WN (1.75"), VSM200WN (2.0")

Type 1- Centerline Ripper Tooth

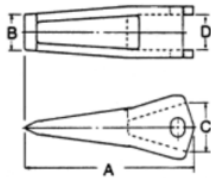

Type 2- Penetration Ripper Tooth

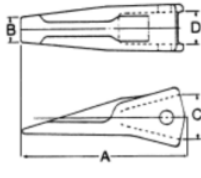

Type 3- Ripper Tooth

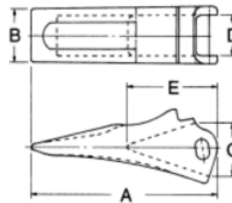

Repair Nose

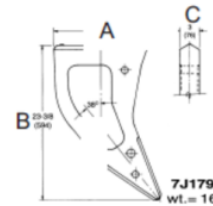

CAT® STYLE RIPPER TOOTH AND SHANK for 951, 955, 140, 140G

Part # & Type	Style	Weight lbs.	A	B	C	D	Pin	Lock
6Y0309 2	Penetration	11.5	11 1/2	2	3 1/8	2 3/8	9W2668	8E6359
9J6586	Shank	51.3					9W2668	8E6359
9J8913	Shank	58.0					9W2668	8E6359

CAT® STYLE RIPPER TEETH AND SHANK for D5, D6, D7, 973, 977, 983, 14G, 16G

Part # & Type	Style	Weight lbs.	A	B	C	D	Pin	Lock
6Y0352 1	Centerline	24.0	14	1 7/8	4 7/16	3 3/32	8E6358	8E6359
6Y0359 1	Penetration	25.8	14 1/4	2 1/16	4 3/8	3	8E6358	8E6359
7J3312 3		31.9	13 29/32	3 5/16	3 29/32	3	4T2479	N/A
9J3139	Shank	134.0						
9W7382	Shank	305.0						

CAT® STYLE RIPPER TEETH AND FIELD REPAIR NOSE ADAPTER for D8, D8K, D8L, D8N, D8R, D9, D9H, D9N, D9R

Part # & Type	Style	Weight lbs.	A	B	C	D	Pin	Protector
9W2451 1	Short	32.2	13	3 1/8	4 7/8	3 3/8	4T2479	6J8814
9W2452 1	Intermediate	36.4	14 13/16	3 9/16	4 7/8	3 3/8	4T2479	6J8814
4T4453 1	Long	35.1	16 5/8	3 3/8	4 7/8	3 3/8	4T2479	6J8814
4T5452 2	Intermediate	33.7	15 5/8	2 1/8	4 7/8	3 3/8	4T2479	6J8814
4T8990	Shank	644.0						
7J1791	Repair Nose	165.3	14 1/4	23 3/8	3			

CAT® STYLE RIPPER TEETH for D9L, D10, D11

Part # & Type	Style	Weight lbs.	A	B	C	D	Pin	Lock
4T4502 1	Intermediate	66.1	17	3	6 5/8	4 1/4	3G0500	N/A
4T4503 1	Long	66.1	19	3	6 5/8	4 1/4	3G0500	N/A
4T5501 2	Short	52.9	14 3/4	3 3/16	6 5/8	4 1/4	3G0500	N/A
4T5502 2	Intermediate	60.2	16 15/16	3	6 5/8	4 1/4	3G0500	N/A
4T5503 2	Long	61.7	18 5/16	3	6 5/8	4 1/4	3G0500	N/A
9W4551 1	Short	88.5	17 5/8	3	8 3/8	4 9/16	6Y2443	

CAT® STYLE RIPPER PROTECTORS

	D8K/L/N/R, D9G/H	D8K/N/R/L, D9N/R/H	D9L/R, D10N	D10, D10R, D11	D11S
Shank Protector	6J8814 or 6J8814W*	8E1848** 3 1/4" shank	9W8365 4 1/4" shank	6Y8960	9N4621
Weight lbs.	24.5 53.2	46.3	86.9	80.0	169.0
Pin/Lock	6Y3394/8E4743	4T2479	6Y3909/4T4707	6Y3909/4T4707	8E2229/8E2230

*Long Version

**Heavy Duty Available

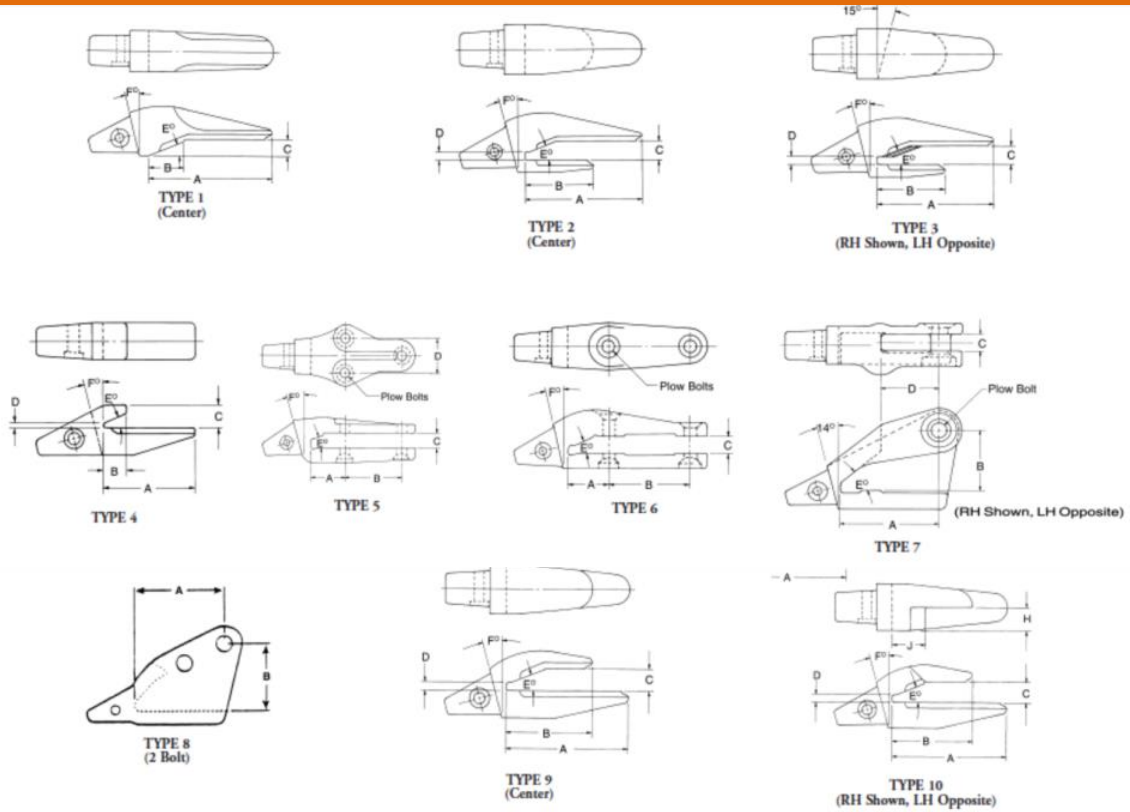

CAT® STYLE ADAPTERS

E & F available on request

CAT® STYLE BOLT ON CENTER ADAPTERS

Part #	Family & Type	Weight lbs.	A	B	C	D	Bolt	Nut
8E2184	J200 6	4.8	2	3	13/16		4F3656	4K0367
9J4207	J200 6	7.5	2 5/8	3 1/2	13/16		2J4771	2J3506
1U0257	J250 6	18.5	2 3/4	4 7/8	1 1/16		5P8136	8J2933
1U0307	J300 6	23.6	2 3/4	4 7/8	1 1/16		5P8136	8J2933
3G5307	J300 5	30.0	3 3/8	5 3/4	1		5P8136	8J2933
3G9307	J300 6	26.3	3 3/8	6 5/16	1 5/16		5P8361	5P8362
4T4307	J300 6	26.9	3 3/16	6 1/2	1 5/16		5P8136	8J2933
9J2307	J300 6	25.7	9 1/2	3	1 1/8		1J3527	2J3507
1U1357	J350 6	44.7	4 1/16	6 1/8	1 13/16		5P8361	5P8362
3G3357	J350 6	34.8	3 7/8	5 7/8	1 11/16		5P8361	5P8362
3G7357	J350 6	46.2	3 3/8	6 1/4	1 1/4		6V8360	5P8362
6I9898	J400 6	54.8	4 3/32	6 1/8	1 1/4		5P8361	5P8362

CAT® STYLE BOLT ON CORNER ADAPTERS

Part #	Family & Type	Weight lbs.	A	B	C	D or Bolt	Bolt	Nut
1U2208	J200 7L	8.4	4 3/4	2 3/16	13/16		6F0196	2J3505
1U2209	J200 7R	8.4	4 3/4	2 3/16	13/16		6F0196	2J3505
3G4258	J250 7L	22.9	5 3/4	4 3/16	1 1/16	3	4J9058	8J2933
3G4259	J250 7R	22.9	5 3/4	4 3/16	1 1/16	3	4J9058	8J2933
6I9250	J250 8L	29.0	7 1/2	6 5/8			4J9058	4F4042
6I9251	J250 8R	29.0	7 1/2	6 5/8			4J9058	4F4042
3G4308	J300 7L	37.7	7	4 3/4	1 1/16	4 1/16	5P8823	5P8362
3G4309	J300 7R	37.7	7	4 3/4	1 1/16	4 1/16	5P8823	5P8362
3G8308	J300 7L	35.9	8	5 1/2	1 9/16	5 1/8	5P8823	5P8362
3G8309	J300 7R	35.9	8	5 1/2	1 9/16	5 1/8	5P8823	5P8362
8E5308	J300 8L	37.2	7 7/8	6 7/16			8T9079	5P8823
8E5309	J300 8R	37.2	7 7/8	6 7/16			8T9079	5P8823
3G5358	J350 7L	50.2	8 1/2	5 5/8	1 9/16	5 1/8	5P8823	5P8362
3G5359	J350 7R	50.2	8 1/2	5 5/8	1 9/16	5 1/8	5P8823	5P8362
8E5358	J350 8L	54.6	5 1/2	7 1/16			6V6535	5P8361
8E5359	J350 8R	54.6	5 1/2	7 1/16			6V6535	5P8361
6I8243	J400 8L	83.0	10 3/4	8 1/8			5P8361	6V6535
6I8244	J400 8R	83.0	10 3/4	8 1/8			5P8361	6V6535

CAT® STYLE WELD ON BOTTOM LEG ADAPTERS

Part #	Family & Type	Weight lbs.	A	B	C	D	E	F
8J7525	J200 4	3.5	3 15/16	1	1	1/4	23°	14°
3G0169	J250 4	9.5	7 1/2	2 5/16	2	5/16	22°	15°

CAT® STYLE WELD ON CENTER DOUBLE STRAPPED ADAPTERS

Part #	Family & Type	Weight lbs.	A	B	C	D	E	F
6Y3224	J220 9	7.3	5 5/16	3 7/16	1 1/16	7/16	22°	8°
6Y3254	J250 9	11.2	6 1/8	5	1 5/16	3/8	22°	9°
3G6304	J300 9	16.8	8	4 9/16	1 5/16	9/16	22°	8°
3G6304HD**	J300 9	16.8	8	4 9/16	1 5/16	9/16	22°	8°
8E9490	J300 9	17.2	8 1/4	5 7/8	1 9/16	1/2	23°	12°
1U1350*	J350 9	30.7	10	7	1 13/16	11/16	22°	14°
3G8354	J350 9	20.3	8 1/4	4 3/4	1 11/16	5/8	35°	8°
6I6354**	J350 9	27.2	9	7 1/4	1 13/16	9/16	22°	12°
6I6404	J400 9	29.5	9 7/8	7 3/4	1 7/8	3/4		
1U1454	J450 9	40.1	10 1/2	8	2 1/8			
114-0464**	J460 2	46.3	12	8	2 1/8	3/4		
6I6464**	J460 9	49.6						
8E3464	J460 2	46.3	12 1/2	9	2 1/8	3/4	22°	12°
8E6464	J460 9	40.1	11 1/8	7 3/8	2 1/8	7/16	24°	9°
107-3554**	J550 2	76.1	14 1/2	12 1/2	2 5/8	1	22°	15°
1U1553	J550 9	62.2	14	10 1/2	2 1/2	1	23°	9°
3G9494	J550 2	67.0	14 1/4	12 5/8	2 5/8	1 1/16	22°	15°
6I6554**	J550 9	77.0	13 1/4	11	2 9/16	1 1/16	22°	9°
6I6604	J600 9	125.7	14 1/2	12	3 1/16	1 3/8	22°	9°
4T4704	J700 2	161.2	18 1/8	13 1/8	3 1/16	1	22°	15°
6I8804	J800 9							

*For Loader Bucket

**Shouldered

CAT® STYLE WELD ON CORNER ADAPTERS

(See page 7 for drawings of types.)

Part #	Family & Type	Weight lbs.	A	B	C	D	E	F
3G6305	J300 10R	17.5	8	4 9/16	1 5/16	9/16	22°	8°
3G6306	J300 10L	17.5	8	4 9/16	1 5/16	9/16	22°	8°
1U1351*	J350 9R	23.1	10	7	1 13/16	11/16	22°	14°
1U1352*	J350 9L	23.1	10	7	1 13/16	11/16	22°	14°
3G8355	J350 10R	19.6	8 1/4	4 3/4	1 11/16	5/8	35°	8°
3G8356	J350 10L	19.6	8 1/4	4 3/4	1 11/16	5/8	35°	8°
6I6405	J400 10R	27.0	9 5/8	7 5/8	1 7/8	3/4		
6I6406	J400 10L	27.0	9 5/8	7 5/8	1 7/8	3/4		
114-0465**	J460 3R	47.0	11	8	2 1/4	7/16		
114-0466**	J460 3L	47.0	11	8	2 1/4	7/16		
8E3465*	J460 3R	47.0	12 1/2	9	2 1/8	3/4	22°	12°
8E3466*	J460 3L	47.0	12 1/2	9	2 1/8	3/4	22°	12°
8E6465	J460 10R	46.5	11 1/8	7 3/8	2 1/8	7/16	24°	9°
8E6466	J460 10L	46.5	11 1/8	7 3/8	2 1/8	7/16	24°	9°
107-3555**	J550 3R	78.3	14 1/2	12 1/2	2 5/8	1	22°	15°
107-3566**	J550 3L	78.3	14 1/2	12 1/2	2 5/8	1	22°	15°
1U1555	J550 10R	62.0	14	10 1/2	2 1/2	1	23°	9°
1U1556	J550 10L	62.0	14	10 1/2	2 1/2	1	23°	9°
3G9495	J550 3R	68.8	15	13 3/8	2 5/8	1 1/16	22°	15°
3G9496	J550 3L	68.8	15	13 3/8	2 5/8	1 1/16	22°	15°
6I6605	J600 9R	133.4	14 1/2	12	3 1/16	1 3/8	22°	9°
6I6606	J600 9L	133.4	14 1/2	12	3 1/16	1 3/8	22°	9°

*For Spade Nose Loader Bucket

**Shouldered

CAT® STYLE FLUSH MOUNTED ADAPTERS

(See page 7 for drawings of types.)

Part #	Family & Type	Weight lbs.	A	B	C	D	E	F
4T1204	J200 1	4.4	7 1/4	1/2	1/2-1		23°	13°
1U1254	J250 1	12.6	9 1/4	2	1		22°	13°
1U1304	J300 1	18.1	9 3/8	2 5/16	1 1/16		22°	14°
1U1354	J350 1	31.7	11 1/4	3 3/4	1 1/2		22°	14°

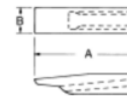
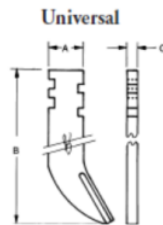
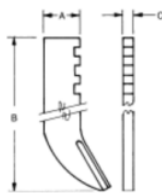

CAT®, GALION®, and CHAMPION® STYLE SCARIFIER SHANKS & TIPS for MOTOR GRADERS

Part #	Style	Weight lbs.	A	B	C	Wedge
9F5124	Shank	12.8	3	17 1/4	1	5K1459
101	Shank Universal	12.0	3	17 1/4	1	5K1459
8110	Shank Champion®	13.4	2 15/16	16 3/4	1	098
6Y5230/2D5572	Tooth	3.0	7 1/8	1 3/4		N/A
31281C	Tooth-Galion®	2.7	6 7/8	1 5/8		N/A
31280D	Shank-Galion®	13.6				N/A

Item	Description	613/613B	Q	613C	Q	615	Q	623	Q	623E/F	Q	760/762	Q	860/862	Q
1	Chain	9J0115	2	2T0104	2	2T0072	2	3G3391	2	2T3038	2	AT32519	2	AT61351	1
2	Flight Bolt Kit	FBK613	1	FBK613C	1	FBK615	1	FBK623	1	FBK623E/F	1	FBK760/762	1	FBK560/862	1
2A	Flight Bolt	OS1603	128	OS1603	120	OS1576	144	OS1576	120	OS1576	120	19H2716	108	19H2716	138
2B	Flight Nut	6B6684	128	6B6684	120	5D3183	144	5D3183	120	5D3183	120	14H1058	108	14H1058	138
2C	Flight Washer	5P8245	128	5P8245	120	5P8247	288	3B4510	120	3B4510	120	3B4512	108	3B4512	138
3	Sprocket	9J1653	2	2T2623 ^a	2	2T0249	2	8J6544	2	2T2891	2	T135637 ^b	2	T135639	2
4	Sprocket Bolt Kit	9J1653BK	1	2T2623BK	1	2T0249BK	1	8J6544BK	1	2T2891BK	1	T135637BK	1	T135639BK	1
4A	Sprocket Bolt	2B0947	16	2B0947	16	1D4610 & 1/8 ea	8 ea	OS1756	16	OS1756	16	19H2725	12	19H3169	10
4B	Sprocket Nut	3B4508	16	3B4508	16	2T3506	16	2T3506	16	2T3506	16	14H1054	12	14H1039	10
4C	Sprocket Washer	1D4719	16	1D4719	16	3B4512	16	3B4512	16	3B4512	16	T10510	24	24M7241	20
5	Flight	8J4174	16	2T0679	15	2T0012	18	8J7122	15	2T3883	15	AT163225	18	AT163233	23
6	Upper Idler Roller	2T3964	2	2T3964	2	2T0046	2	3G7490	2	3G7490	2	T58511A	2	T58511A	4
7	Center Idler/Roller	8J8170	2	8J8170	2	2T0047	2	3G1086	2	3G1086	2	N/A	2	N/A	-
8	Bottom Idler/Roller	9J0106 ^c	2	9J0106 ^c	2	2T0048	2	8J6562	2	8J6562	2	T73150	2	T135867	2
9	Upper Ejector Roller	8J8250 ^d	2	8J8250 ^d	2	5F8001	2	5F8001	2	5F8001	2	T73150BK Bolt 19H1471 Nut 14H1058 Washer T10510	2	T135867BK Bolt 19H1471 Nut 14H1058 Washer T10510	2
10	Middle Ejector Roller	5J9643 ^e	2	5J9643 ^e	2	2T0326	2	9J7350	2	2T2911	2		2		1
11	Lower Ejector Roller	8J8248 ^f	2	8J8248 ^f	2	6J9224	2	8W4646	2	1447299	2		2		12
12	Floor Roller with Nut	6J1702	4	6J1702	4	6J1702	4	6J1702	4	6J1702	4		4		12
13	Bracket	2T3337	4	2T3337	4	2T3337	4	3G7872	4	3G7872	4		4		12
14	Bolt	1D4609	8	1D4609	8	1D4609	8	1D4609	8	1D4609	8		8		
15	Washer	8T4994	8	8T4994	8	8T4994	8	3B4512	8	3B4512	8		8		
16	Floor Guide RH	7J5355	1	7J5355	1	8J7210	1	8J7210	1	8J7210	1		1		
17	Floor Guide LH	7J5356	1	7J5356	1	8J7211	1	8J7211	1	8J7211	1		1		
18	Bolt	1A0458	10	1A0458	10	1H5257	10	1H5257	10	1H5257	10		10		
19	Washer	3B4512	10	3B4512	10	3B4516	10	3B4516	10	3B4516	10		10		
20	Skid Weld on	N/A	-	N/A	-	3G0901	2	3G0901	2	3G0901	2		2		
21	Insert	N/A	-	N/A	-	N/A	-	2T1955	2	2T1955	2		2		
22	Router Bit	9F1831	2	4T4336	2	4B6655	2	4B6655	2	4B6655	2	U16420(RFD)	1	T114519 (RH)	1
22A	Router Bit HD (CAT®)					7J3023	2	7J3023	2	7J3023	2	U16421(LH)	1	T114520 (LH)	1
23	Plow Bolt	8S9092	8	8S9092	6	32801	10	1J5607	10	1J5607	10	5J4773	6	5J4771	4
24	Plow Nut	4K0367	8	4K0367	8	2J3507	2	2J3507	2	2J3507	2	2J3506	6	2J3506	4
24A	Plow Washer	5P8247	8	5P8247	6	N/A	-	N/A	-	N/A	-	N/A	-	N/A	-
25	Center Blade	4T6611	1	4T6611	1	9W5807 ^g	1	4T2887	1	4T2887	1	U15809	1	T145455	1
26	End Blade	4T6613	2	4T6613	2	9W5806 ^g	2	4T6612	2	4T6612	2	U15808	2	T145456	2
27	Plow Bolt	4F7827	15	4F7827	15	4F9058 ^h	17	4F4042	20	4F4042	20	5J4773	15	5J4771	34
28	Plow Nut	2J3506	15	2J3506	15	2J3507	17	2J3507	20	2J3507	20	2J3506	20	2J3506	34
29	Moldboard	7J5132	1	7J5132	1	2T2479	1	2T1969	1	2T1969	1		1		
30	Adapter	9J8455	4	9J8455	4	9J2307	4	9J2307	4	9J2307	4	150X160	4	860X220	5
31	Flying Tiger Tooth (CAT® only)	1U3252FT	4	1U3252FT	4	1U3302FT ⁱ	4	1U3302FT	4	1U3302FT	4	X160	4	X220	5
32	Pin	8E6258	4	8E6258	4	9J2308	4	9J2308	4	9J2308	4	P160	4	P160	5
33	Retainer	3G9609	4	3G9609	4	3G9609	4	3G9609	4	3G9609	4	N/A	4	N/A	-

1. S# 7281307 and up
2. For 5/8 in bolt hole sprocket 2T0704 use 2T2623 with 16 each of a 5/8 to 3/4" reducer bushing, a 2B0947 bolt, a 1F7958 nut and a 3P8245 washer.
3. For S# 4721-1339 use 7J5104
4. For S# 4721-1339 use 7J5105
5. For S# 4721-1339 use 2J3205
6. For S# 4721-1339 use 2J3205
7. For S# 4721-1339 use 2J3205
8. For S# 4721-1339 use 2J3205
9. For S# 4721-1339 use 2J3205
10. For S# 4721-1339 use 2J3205

615

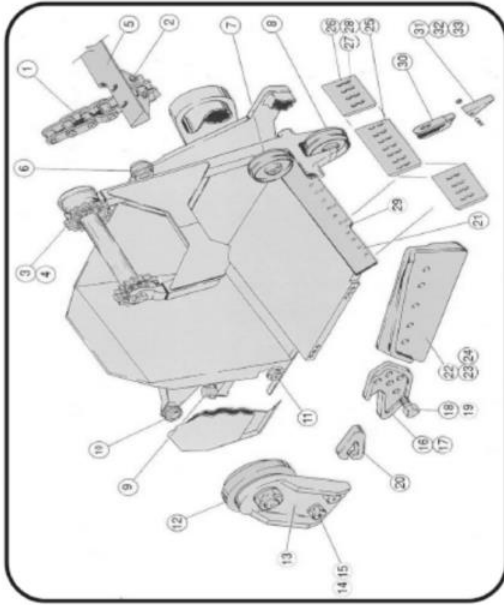

623/623B/623E/623F

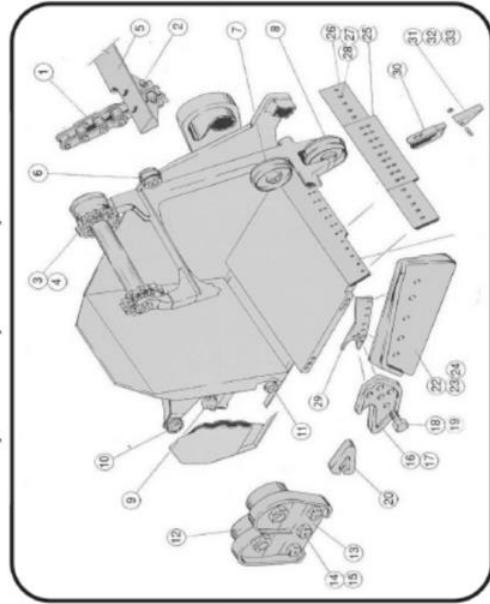

613/613B/613C

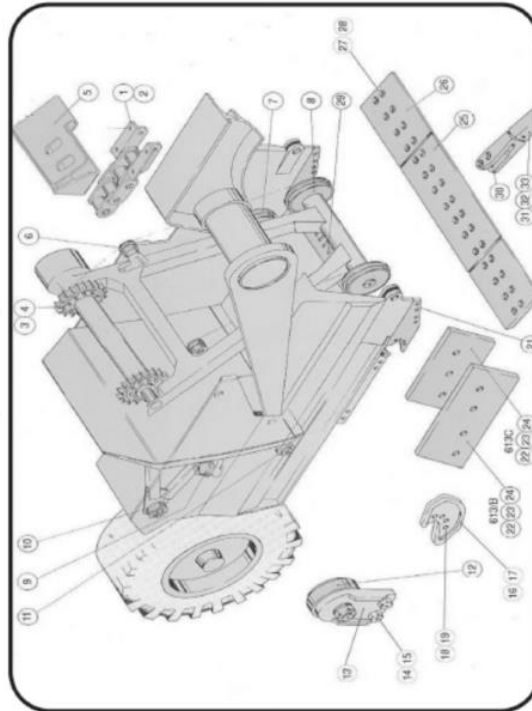

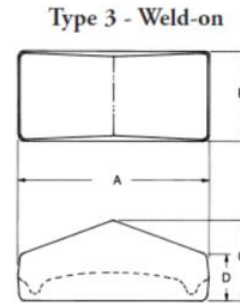
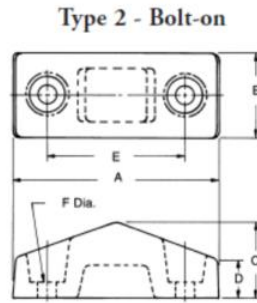
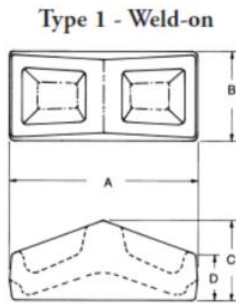

CAT® COMPACTOR FEET, CLEANER BARS, AND STANDS

Part # & Type	Style	Weight lbs.	A	B	C	D	E	F
2V7053 1	815B Foot	9.0	6 5/8	3 3/16	2 13/16	1 5/8		
4V0668 3	825C Foot	15.1	8 7/16	3 7/16	3 1/2	1 15/16		
4V3851 3	815, 815F Foot	8.2	6 11/16	3 3/16	2 13/16	1 5/8		
7K2939 3	824/5, 834/5 Foot	13.8	8 9/16	3 3/16	2 1/8	1 5/8		
8K9189 2	815, 815F Foot BOLT - 7K6692 NUT - 7H3607	8.6	6 11/16	2 3/4	2 1/2	1 1/4	4 1/2	11/16
2V6628 2	825, 835 BOLT - 0T0856 NUT - 6B6682	12.7		WASHER - 5H1504				
5V4311	815B Cleaner Bar	2.1	Tip - 3G8250 Pin - 8E6258 Lock - 8E6259					
4S7928	825, 835 Cleaner Bar	12.8						
7K6908	815 Stand	10.0	Weld on Stand for 8K9189, 4V3851, and 2V7053 Feet					
3S3225	815, 815F, 825B, 835	4.4	Cleaner Bar Retainer					
3S3228	834, 835, 824B, 825B/C	15.6	Cleaner Bar					

CAT® D6C/D, D8K, D9L, D10N, D11N, ESCO® AND CAT® STYLE HEAVY DUTY CAST END BITS

CAT® #	Style	Type	Weight lbs.	Bolt	Nut	Quantity
3G8319C	D6C/D	Right	42.0	4F7827	2J3506	6
3G8320C	D6C/D	Left	42.0	4F7827	2J3506	6
3G8301C	D8K	Right	74.0	4J9058	2J3507	7
3G8302C	D8K	Left	74.0	4J9058	2J3507	7
8E4541	D10N(2 1/4")	Right	281.0	5P8823	3K9770	7
8E4542	D10N(2 1/4")	Left	281.0	5P8823	3K9770	7
8E4545	D11N	Right	371.0	5P8823	3K9770	9
8E4546	D11N	Left	371.0	5P8823	3K9770	9

* CAST END BITS ARE AVAILABLE IN MANY TYPES. CALL FOR AVAILABILITY.

CAT®, HENSLEY®, JOHN DEERE®, ESSCO®, AND UNIVERSAL SIDECUTTERS

Part #	Type	Weight lbs.	Bolt	Nut				
B330	RH	45.0	4F4042	2J3507				
B331	LH	45.0	4F4042	2J3507				
PDE31329	Universal	35.6	5J2409 (3")	2J3505 (7/8")				
T1156A	LH	55.0	5J2409	2J3505				
T1157A	RH	55.0	8H5772	2J3507				
7Y0203	LH	16.9	093-7676	096-7074				
7Y0204	RH	16.9	093-7676	096-7074				
8J9614	LH	49.0	7Y2146	2J3507				
8J9615	RH	49.0	7Y2146	2J3507				
CE17748R3	RH	50.7	5J2409 (3")	2J3505 (7/8")				
CE17748L3	LH	50.7	5J2409 (3")	2J3505 (7/8")				

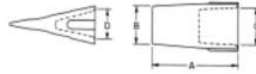

HENSLEY® STYLE PARABOLIC TEETH

Part #	Style	Weight lbs.	A	B	C	D	Steel Pin	Flex Pin
X156	Short	1.4	4 1/2	1 13/16	1 9/16	1 5/8	P156	N/A
X156F	Flare	2.8	5	4 3/4	1 9/16	1 5/8	P156	N/A
X156L	Long	2.7	6	1 15/16	1 9/16	1 5/8	P156	N/A
X156LP	HD Long Panel	3.6	6	2 1/4	1 5/8	1 5/8	P156	N/A
X156T	Tiger	2.0	5 7/8		1 9/16	1 5/8	P156	N/A
X156TL	Tiger Long	2.0	6		1 5/8	1 5/8	P156	N/A
X156WT	Twin Tiger	3.5	6	3 1/4	1 5/8	1 5/8	P156	N/A
X156WTL	Twin Tiger Long	3.5	6 1/4	3 1/4	1 9/16	1 5/8	P156	N/A
X160	Long	3.5	6 5/8	2 5/16	1 5/8	2 3/8	P160	N/A
X160ST	Star Penetration	4.4	7 3/4	1	1 5/8	2 3/8	P160	N/A
X162HD	HD Long	4.2	6 5/8	2 1/8	1 3/4	2 1/2	N/A	162P
X220	Long	6.0	7	2 7/8	2 1/4	2 1/8	P160	N/A
X220T	Tiger	6.2	7 3/4		2 1/4	2 1/8	P160	N/A
X220WT	Twin Tiger	8.5	7 7/8	4 1/8	2 1/4	2 1/8	P160	N/A
X290	Long	8.7	8	3 1/4	2 7/8	2 11/16	K290S	P290STP
X290F	Flare	11.6	8	6 1/4	2 7/8	2 11/16	K290S	P290STP
X290RC	Rock Chisel	10.2	8 3/4	3	2 7/8	2 11/16	K290S	P290STP
X290TL	Tiger Long	8.1	9 5/8	3/16	2 7/8	2 11/16	K290S	P290STP
X290WTL	Twin Tiger Long	9.9	9 5/8	4 5/8	2 7/8	2 11/16	K290S	P290STP
X310	Long	7.3	7 5/8	3 1/2	3	2 1/4	P160	N/A
X310ABR	HD Abrasion	15.5	8 3/4	4	3	2 1/4	P160	N/A
X310F	Flare	7.5	7 5/8	6	3	2 1/4	P160	N/A
X310T	Tiger	10.7	9 3/4		3	2 1/4	P160	N/A
X310WT	Twin Tiger	12.6	9 1/2	4 3/4	3	2 1/4	P160	N/A
X330	Long	13.8	9 1/8	3 5/8	3 3/8	3 3/16	K330S	P330STP
X330ABR	HD Abrasion	15.5	9 1/4	4 1/4	3 3/8	3 3/16	K330S	P330STP
X330F	Flare	18.1	9 5/8	7 1/4	3 3/8	3 3/16	K330S	P330STP
X330PT	ABR/Penetration	20.0	11 1/4	3 15/16	3 3/8	3 3/16	K330S	P330STP
X330RC	Rock Chisel	15.2	10	3 1/2	3 3/8	3 3/16	K330S	P330STP
X330T	Tiger	11.2	11	3/16	3 3/8	3 3/16	K330S	P330STP
X330WT	Tiger	14.7	11	5 1/4	3 3/8	3 3/16	K330S	P330STP
X370	Long	18.5	10 1/4	4 1/8	3 5/8	3 3/8	K370S	P370STP
X370ABR	HD Abrasion	25.6	11 3/4	4 5/8	3 5/8	3 3/8	K370S	P370STP
X370F	Flare	22.9	10 1/4	8	3 5/8	3 3/8	K370S	P370STP
X370PT	ABR/Penetration	32.5	11 5/8	4 7/8	3 5/8	3 3/8	K370S	P370STP
X370T	Tiger	18.2	12		3 5/8	3 3/8	K370S	P370STP
X370WT	Twin Tiger	21.0	12	6	3 5/8	3 3/8	K370S	P370STP
X400	Long	16.0	9 5/8	4 1/8	4	3	N/A	P350/400
X400ABR	HD Abrasion	28.1	11	4 3/4	4	3	N/A	P350/400
X400F	Flare	7.5	7 5/8	6	2 7/8	2 1/4	N/A	P350/400
X400PT	ABR/Penetration	26.1	11 3/4	5 1/8	4	3	N/A	P350/400
X400T	Tiger	15.0	12		4	3	N/A	P350/400
X400WT	Twin Tiger	24.1	12	6 1/8	4	3	N/A	P350/400
X400WTL	Twin Tiger Long	23.1	13	5 11/16	4	3	N/A	P350/400
X410	Long	21.7	11 3/16	4 7/16	4 1/16	3 3/4	K410S	P410STP
X410T	Tiger	22.6	13 3/8		4 1/16	3 3/4	K410S	P410STP
X410WT	Twin Tiger	27.6	13 3/4	6 5/8	4 1/16	3 3/4	K410S	P410STP
X450	Long	28.2	12 1/4	4 7/8	4 9/16	4 5/16	K450S	P450
X450PT	ABR/Penetration	43.8	13 7/8	5 1/2	4 9/16	4 5/16	K450S	P450
X450T	Tiger	31.3	15		4 9/16	4 5/16	K450S	P450
X450 WT	Twin Tiger	37.5	15	7 1/4	4 9/16	4 5/16	K450S	P450
X475	Long	34.8	12 1/8	5 3/4	4 3/4	3 1/2	N/A	P475
X475TL	Tiger Long	32.0	13 3/4		4 3/4	3 1/2	N/A	P475
X475WTL	Twin Tiger Long	37.3	14	7	4 3/4	3 1/2	N/A	P475
X500	Long	48.5					N/A	K500R
X500RC	Rock Chisel	57.0	15 1/2	5 1/4	5	4 5/8	N/A	K500R
X500RP3	HD ABR/Penetration	80.0	16 1/8	5 1/4	5	4 5/8	N/A	K500R
X500SYL	Excavator Tooth	50.0	15 3/4	6	5	4 5/8	N/A	K500R
X550RC	Rock Chisel	82.0	17 1/2	6 3/4	5 7/8	5 5/8	N/A	K550R
X550RP2	ABR/Penetration	123.0	19 1/2	6	5 7/8	5 5/8	N/A	K550R
X550RP3	HD ABR/Penetration	140.0	20	6 1/8	5 7/8	5 5/8	N/A	K550R
X600RS2	Rock Penetrator	61.4	14 3/4	5 7/8	5 3/4	4 5/8	N/A	P600HD

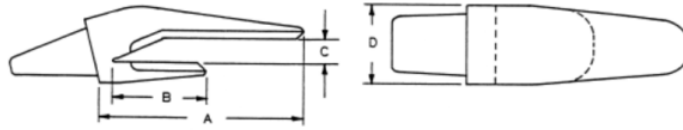

HENSLEY® STYLE PARABOLIC ADAPTERS

Part #	Style	Weight lbs.	A	B	C	D	Steel Pin	Flex Pin
835X156	Weld-on	3.5	4 3/4	2 1/4	11/16	2	P156	N/A
550X156	Weld-on	4.7	6 1/4	2 13/16	1 1/8	2 1/8	P156	N/A
552X156	Weld-on	5.4	6	3 1/2	13/16	2 1/4	P156	N/A
850X160	Weld-on	5.5	6	5 3/4	1 1/4	2 1/4	P160	N/A
658X160	Weld-on	10.6	8	4 3/8	1 1/2	2 1/4	P160	N/A
109X220	Weld-on	16.1	8 1/4	5 1/4	1 5/16	3	P160	N/A
153X310	Weld-on	20.9	10	4 3/4	1 9/16	3 3/4	P160	N/A
127X290	Weld-on	21.5	10	4 3/4	1 5/16	3 5/8	K290S	P290STP
158X290	Weld-on	22.1	9 1/2	5 11/16	1 1/2	6 5/8	K290S	P290STP
158X330	Weld-on	34.3	10 1/4	6 3/4	1 9/16	4 1/2	K330S	P330STP
940X370	Weld-on	36.4	11 3/4	5 1/4	2 1/16	4 5/8	K370S	P370STP
940X410	Weld-on	43.4	12	5 1/4	2 1/16	5 1/8	K410S	P410STP
988X475	Weld-on	86.3	13 5/8	12 3/8	2 1/16	5 3/4	N/A	P475
802X400	Weld-on	48.0	12 3/8	6 5/16	2 1/16	5 1/8	N/A	P350/400
303X450	Weld-on	69.0	13	8 5/8	2 9/16	5 3/4	K450S	P450

HENSLEY® STYLE '5' SERIES TEETH

Part #	Style	Weight lbs.	A	B	C	D	Steel Pin	Flex Pin
225	Long	6.2	7	2 7/8	2 1/4	2 1/8	N/A	P225
295	Long	8.4	8	3 1/4	2 31/32	2 17/32	P295	N/A
335	Long	11.4	9 1/4	3 3/4	2 15/16	3 7/16	P335	N/A
335RC	Rock Chisel	16.1	10 1/8	3 1/2	2 15/16	3 7/16	P335	N/A
335T	Tiger	12.8	11		2 15/16	3 7/16	P335	N/A
335WT	Twin Tiger	13.9	11	5 1/4	2 15/16	3 7/16	P335	N/A
385	Long	22.7	10 3/4	4 3/8	4 3/8	4	P385	N/A
385RC	Rock Chisel	25.3	11 5/8	4 1/16	4 3/8	4	P385	N/A
385T	Tiger	24.0	12 5/8		4 3/8	4	P385	N/A
385WT	Twin Tiger	23.8	12 5/8	6	4 3/8	4	P385	N/A
485	Long	48.3	13 7/8	6 1/8	5	4 15/32	P485	N/A
485RC	Rock Chisel	58.5	15	5 1/8	5	4 15/32	P485	N/A
485RP3	HD ABR/Penetration	76.0	15 1/4	5 3/16	5	4 15/32	P485	N/A

CHOCKY BARS (EXHIBIT A)

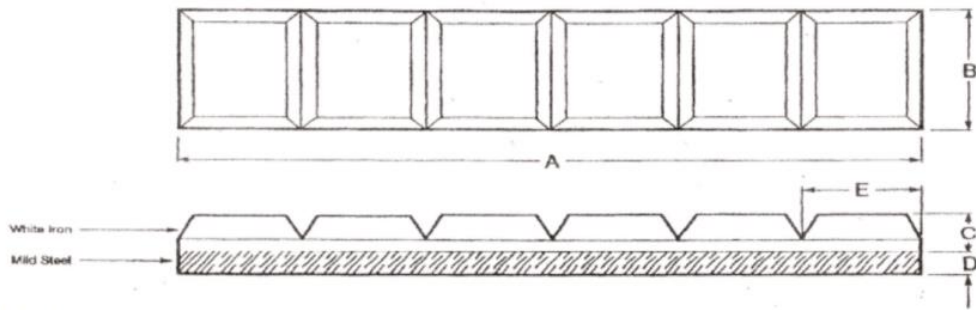

CHOCKY BARS

Part #	Weight lbs.	A	B	C	D	E	
CB40	3.1	9 7/16	1 9/16	19/32	5/16	1 9/16	
CB50	4.2	9 7/16	1 31/32	19/32	5/16	1 9/16	
CB65	5.3	9 7/16	2 9/16	19/32	5/16	1 9/16	
CB100	9.5	9 7/16	3 15/16	19/32	5/16	1 9/16	
CB130	12.3	9 7/16	5 1/8	19/32	5/16	1 9/16	

WEAR BUTTONS (EXHIBIT B)

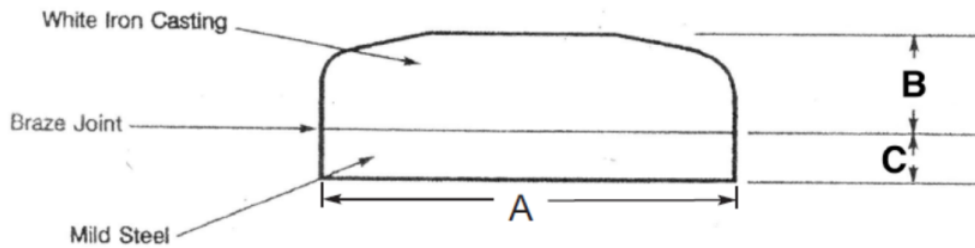

WEAR BUTTONS (WHITE IRON)

Part #	Weight lbs.	A	B	C	D	E	
WB60	0.9	2 3/8	3/4	3/8			
WB75	2.0	2 3/4	1	3/8			
WB90	2.4	3 1/2	13/16	3/8			
WB115	4.8	4 1/2	1 1/4	1/2			
WB150	10.6	6	1 5/8	5/8			

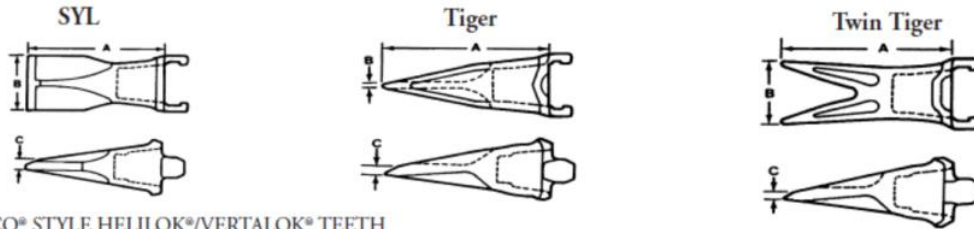

ESCO® STYLE HELILOK®/VERTALOK® TEETH

Part #	Style	Weight lbs.	A	B	C	Horseshoe Lock	Vertalok®
21SYL	SYL	7.2	7 1/2	3	1/2	21LKS	N/A
27S6F	Flare	13.6	8 3/4	6	1/4	27LKS	27V/KIT
27SYL	SYL	10.6	8	3 1/2	5/8	27LKS	27V/KIT
27VIP	Tiger	9.0	7 3/4			27LKS	27V/KIT
27TVIP	Twin Tiger	10.0	7 3/4	3 3/4		27LKS	27V/KIT
37S7F	Flare	22.7	11	7	1/3	37LKS	37V/KIT
37SYL	SYL	17.6	9 1/2	4 3/4	23/32	37LKS	37V/KIT
37VIP	Tiger	13.5	9 1/2			37LKS	37V/KIT
37TVIP	Twin Tiger	16.8	9 1/2	6 1/4		37LKS	37V/KIT
47S9F	Flare	35.0	12 5/8	9	19/50	47LKS	47V/KIT
47SYL	SYL	25.8	11	5	1	47LKS	47V/KIT
47VIP	Tiger	22.1	11			47LKS	47V/KIT
47TVIP	Twin Tiger	24.9	11	5 1/8		47LKS	47V/KIT
57S9F	Flare	65.7	14 3/4	9		57LKS	57V/KIT
57SYL	SYL	41.0	13	6	1	57LKS	57V/KIT
57VIP	Tiger	34.0	13 1/8			57LKS	57V/KIT
57TVIP	Twin Tiger	40.8	13 1/8	5 7/8		57LKS	57V/KIT



ESCO® STYLE CONICAL and SUPER CONICAL® TEETH

Part #	Style & Type	Weight lbs.	A	B	C	D	E	Pin	Lock
18TL	Dual Purpose 1	2.2	2 5/8	1 1/2	1 3/16	5 3/4	2 3/16	18-20PN	18-20LK
22S	Sharp 1	3.5	3 1/2	2 5/16	2 1/4	6 1/2	2 1/8	22PN	22LK
25TF	1	6.8	3 9/16	2 3/8	2 9/16	7	3 1/4	25-30PN	25-30LK
25S	Sharp 1	5.0	3 9/16	2 3/8	2 9/16	7	2 1/2	25-30PN	25-30LK
30S	Sharp 1	5.9	3 3/16	2 3/8	3	7 1/8	3 3/8	25-30PN	25-30LK
30VIP	Tiger 1	6.8	3 3/16	2 3/8	3	8 3/4		25-30PN	25-30LK
35S	Sharp 1	7.7	3 13/16	2 7/8	3 1/2	8 3/8	2 5/8	35PN	35-40LK
35VIP	Tiger 1	8.2	3 7/8	2 13/16	3 1/2	10 9/16		35PN	35-40LK
40S	Sharp 1	14.1	4 1/4	3 1/8	4	9 3/8	4 3/16	40PN	35-40LK
40VIP	Tiger 1	12.8	4 3/4	3 1/2	4 1/2	8 9/16		40PN	35-40LK
45S	Sharp 1	17.0	4 3/4	3 1/2	4 1/2	10 5/8	4 3/4	45PN	45LK
45VIP	Tiger 1	17.4	4 3/4	3 1/2	4 5/16	13 5/8		45PN	45LK
50S	Sharp 1	22.5	5 3/8	3 13/16	4 7/8	11 1/8	5 11/16	50PN	50LK
65SP	Sharp Penetration 1	61.0	7 1/8	5 1/4	6 3/8	14 3/4	6 1/4	65PN	65LK

Side Cutter: PDE31329 (Universal) 35.6 lbs 3" Bolt-5J2409 7/8" Nut-2J3505

ESCO® and KELLY® STYLE RIPPER TEETH

Part #	Style & Type	Weight lbs.	A	B	C	D	E	Pin	Lock
25R12	Ripper Tooth 3	11.4	5 3/4	3 3/8	2 5/8	11 1/8	1 7/8	25RP	25RB
35R14A	Ripper Tooth 3	26.0	8 1/16	4 5/8	3 9/16	14	2 5/8	35RP	35RB
54D16	Ripper Tooth 2	37.0	15 1/2		5 3/4	7 1/4	1		

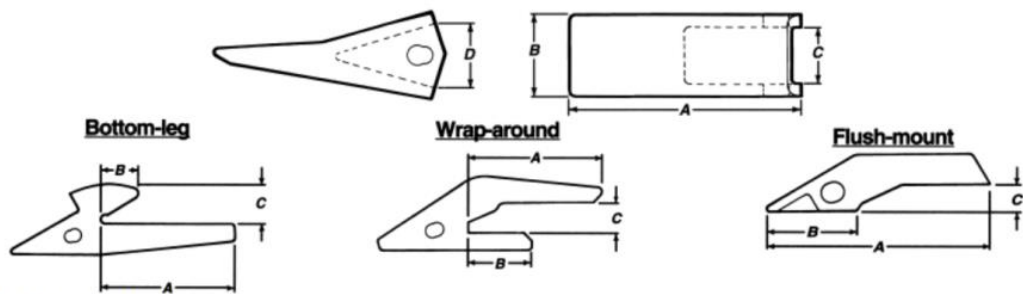

H & L® STYLE TEETH

Part #	Style	Weight lbs.	A	B	C	D	Pin	Lock
11A	Trencher Tooth	0.7					N/A	N/A
00SP	Crimp-on Fab	0.5	3 5/16	2 3/8	1 1/16	1	N/A	N/A
1 3/4	Crimp-on Fab	1.2	7	1 1/4	3/4	1 1/5	N/A	N/A
2A	Crimp-on Fab	0.9	4 1/8	1 3/4	1 1/16	1 1/4	N/A	N/A
3CH	Crimp-on Fab	1.7	4 1/2	2 1/4	1 1/2	1 5/8	N/A	N/A
3CHS	Cast Short	1.5	4 7/8	2 1/4	1 1/2	1 3/4	N/A	N/A
3CHL	Cast Long	2.2	5 1/2	2 1/8	1 1/2	1 3/4	N/A	N/A
23SP	Short	2.7	5 1/8	2 1/16	1 9/16	1 11/16	230PN	N/A
23	Long	3.3	6 1/4	2 3/8	1 9/16	1 11/16	230PN	N/A
23F	Flare	3.0	5 1/4	4 3/8	1 14/25	1 2/3	230PN	N/A
23HD	Fabricated	2.0	5	3 1/4	1 9/16	1 11/16	230PN	N/A
23RC	Rock Chisel	3.1	6 1/2	1 3/4	1 1/2	1 20/29	230PN	N/A
23T	Tiger	2.3	6 1/16		1 9/16	1 11/16	230PN	N/A
23TL	Tiger Long	2.2	6 7/16		1 9/16	1 11/16	230PN	N/A
23W	Wing Tip	3.2	5 3/4	1 15/16	1 9/16	1 11/16	230PN	N/A
23WT	Twin Tiger	3.4	6 1/4	2 15/16	1 9/16	1 11/16	230PN	N/A
23WTL	Twin Tiger Long	2.6	6 7/16	3	1 9/16	1 11/16	230PN	N/A
23FT	Flying Tiger	3.1	6 11/16		1 9/16	1 11/16	230PN	N/A
23ST	Star Penetration	2.8	6 1/16		1 9/16	1 11/16	230PN	N/A
2400	Long	4.1	7 1/2	2 1/8	1 9/16	2 1/8	240PN	N/A
2500	Long	5.2	7 7/8	2 7/8	2 3/32	2 1/8	250PN	N/A
2500ST	Star Penetration	6.1	8 1/2		2 3/32	2 1/8	250PN	N/A
2700	Long	9.1	7 5/16	3 13/16	2 7/8	2 1/4	270PN	N/A

H & L® STYLE ADAPTERS

Part #	Style	Weight lbs.	A	B	C	D	Pin	Lock
2AF	Flush Mount for 2A	2.0	6 1/4	1/2	5/16		N/A	N/A
1002-3C	Flush Mount for 3CH	3.7	8.0	3 1/2	1		N/A	N/A
230W0	Bottom Leg	3.3	8 1/8	3 1/16	13/16		230PN	N/A
230FL	Flush Mount 22°	4.0	8 1/8	3 1/16	13/16		230PN	N/A
2300FL	Flush Mount 30°	3.5	8 1/4	2 1/4			230PN	N/A
2740-MW-23	Wrap 3/4" lip	4.0	6 1/16	2 7/8	13/16		230PN	N/A
2740-ZW-23	Wrap Around	4.1	6 1/16	2 7/8	1		230PN	N/A
2740-AFW-23	Adapter Flared	4.3	6 1/16	2 7/8	1		230PN	N/A
2740-24	Wrap Around	7.4	5 9/16	2	1 3/8		240PN	N/A
2740AW-252	Wrap Around	7.5	5 5/8	1 15/16	1 3/8		250PN	N/A
3000W-27	Wrap Around	13.1	6 1/4	1 9/16	1 11/16		270PN	N/A

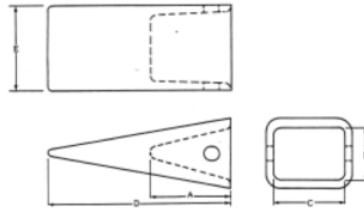

JOHN DEERE® STYLE TEETH for 544E, 644E, 455G, 555G

Part #	Style	Weight lbs.	A	B	C	D	E	Pin	Lock
T103189	Long	5.7	2 1/2	1 11/16	2 1/4	6 3/4	2 3/4	T112195	T112196
T105690	ABR Penetration	4.5	2 1/2	1 11/16	2 1/4	7	3/4	T112195	T112196

JOHN DEERE® STYLE TEETH for 450B/C, 455 D/E, 555 D/E

Part #	Style	Weight lbs.	A	B	C	D	E	Pin	Lock
T29887	Long	2.8	1 13/16	1 13/16	2 7/16	6 1/4	2 15/16	P160	N/A

JOHN DEERE® STYLE TEETH for 655B, 755B, 744E

Part #	Style	Weight lbs.	A	B	C	D	E	Pin	Lock
T69647	Long	10.2	4 3/8	3 1/8	2 1/2	9	2 1/2	9J2308	3G9609



JOHN DEERE® STYLE ADAPTERS

Part #	Style	Weight lbs.	A	B	C	D	E
T112164	Adaptor Bolt-On	9.3	6 7/16	2 13/16	3/4	3 1/8	
T104673	Adaptor Bolt-On	27.5	9 5/8	9 5/8	9 5/8	1 3/8	3 1/4
U16864	Adaptor Bolt-On	15.2	11 1/2	6	1 1/4	2 1/2	

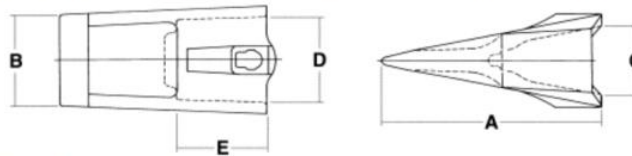

HENDRIX® STYLE TEETH AND DREDGE PARTS

Part #	Style	Weight lbs.	A	B	C	D	E	Pin
214P	Long	12.3	8 1/2	3 5/8	2 3/4	3 15/16	4 3/8	4EP
214T	Tiger	11.5	6		2 3/4	3 15/16	4 3/8	4EP
314P	Long	13.9	9 3/8	4	2 15/16	3 15/16	4 5/16	4EP
414P	Long	18.1	10	4 1/2	3 1/4	4 15/16	4 3/8	4EP
885	Long	56.9	13 9/16	6 1/8	4 7/8	6 5/16	6 3/8	5BP
1285B	Long	83.0	14 7/16	7	7	8 11/16	6 7/16	5BP
1385B	Long	86.0	15 13/16	5 1/8	7 1/8	8 13/16	8 7/16	5BP
H9801	Dredge Point	14.3			Lock - 1086LKR		Pin - F4A5795AHX	
H9118	Dredge Repointer	1.5						
H9801WN	Weld-on Nose	13.9						

BOBCAT® STYLE TOOTH AND ADAPTER

Tooth	Weight	Pin	Pin Style	Adapter	Bolt	Nut			
6728801	2.2	P156	Roll	6725278	6729510	95D10			
6737325	2.16	6737326	Flex	6725278FPA	6729510	95D10			

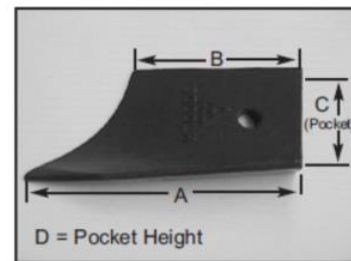
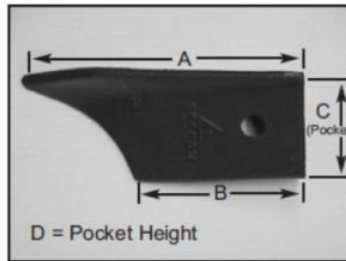
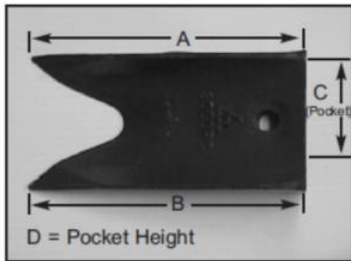

ADCO® STYLE TEETH AND ADAPTER NOSES

Part #	Style	Weight lbs.	A	B	C	D	Pin	Lock
100C	Center	3.0	5 3/4	5 3/4	1 5/8	1 5/8	P156	N/A
100RH	Right Tiger	3.1	5 3/4	5 3/4	1 5/8	1 5/8	P156	N/A
100LH	Left Tiger	3.1	5 3/4	5 3/4	1 5/8	1 5/8	P156	N/A
3000RC	Center	8.0	8 1/4	8 1/4	4 3/16		P160	N/A
3000RH	Right Tiger	5.9	8 1/4	5			P160	N/A
3000LH	Left Tiger	5.9	8 1/4	5			P160	N/A
3010WNRC	Center w/o Nose	10.5					P160	N/A
3010RWN	Right w/o Nose	7.5					P160	N/A
3010LWN	Left w/o Nose	7.5					P160	N/A
400C	Center	17.3					8E6358	8E6359
400RH	Right Tiger	20.2					8E6358	8E6359
400LH	Left Tiger	20.2					8E6358	8E6359
4000RH	Right Tiger	12.5					P160	N/A
4000LH	Left Tiger	12.5					P160	N/A
4010WNR	Right w/o Nose	15.5					P160	N/A
4010WNL	Left w/o Nose	15.5					P160	N/A

FORD® STYLE TOOTH AND ADAPTER

Part #	Style	Weight lbs.	A	B	C	D	Pin	Lock
555	Long	2.5	5 3/4	2	1 21/32	1 13/32	062380	N/A
2740-555	Adapter Weld-On	4.8	4 3/4	2 3/16	1 1/16	2 5/16	062380	N/A

KOMATSU® STYLE TEETH

(See page 2 for drawing.)

Part #	Style &	Model	Weight lbs.	A	B	C	D	Pin	Lock
175-78-31230	Ripper	D85/155	32.2	7 1/4	5 3/16	3 1/4	13 1/8	175-78-21740	N/A
195-78-21331	Ripper	D355/455	42.2	8 5/8	6 1/6	3 3/16	14 1/2	175-78-21740	N/A
205-70-19570	Long	PC100/200	10.2	8 3/4	3	2 7/8	3	092-44-02496	N/A
207-70-14151	Long	PC220/360	16.0	9 3/4	3 3/4	4 1/2	4 9/16	175-78-21740	N/A
207-70-14151T	Tiger	PC220/360	16.0	11 1/4		4 1/2	4 9/16	175-78-21740	N/A
207-70-14151WT	Twin Tiger	PC220/360	19.3	11 1/4	6 11/16	4 1/2	4 9/16	175-78-21740	N/A
208-70-14152	Long	PC400	23.3	10 3/4	4 5/16	5	5 3/4	092-44-03036	N/A
208-70-14152T	Tiger	PC400	27.7	14		5	5 3/4	092-44-03036	N/A
208-70-14152WT	Twin Tiger	PC400	30.1	14	4 1/4	5	5 3/4	092-44-03036	N/A
20T-70-13130	Mono Block Bolt-on	PC30/40	5.5	9 3/8	1 3/4	1 3/4		Bolt - 3F5108	Nut - 4K0367
423-847-1140	Long	WA350/470	16.7	10 1/4	4 13/16	4 1/2	5	175-78-21740	N/A
426-847-1110	Long	WA500/600	26.7	11 1/4	4 1/16	5 1/4	5 1/2	426-847-1130	N/A
426-847-1110PT	ABR/Penetration	WA500/600	47.0	13	4 1/2	5 3/4	5 1/2	426-847-1130	N/A

FIAT® STYLE TOOTH for FL14 DOZER, 161 SCRAPER, 645 LOADER

(See page 2 for drawing.)

Part #	Style	Weight lbs.	A	B	C	D	Pin	Lock
20853	Long	4.6	7 3/8	3	1 9/16	2 1/16	240PN	N/A

HYUNDAI® STYLE TOOTH

(See page 2 for drawing.)

Part #	Model	Weight lbs.	A	B	C	D	Pin	Lock
E161-3027	R130/200	11.1	8 1/2	3 3/4	3 1/4	4	8E6358	3G9549

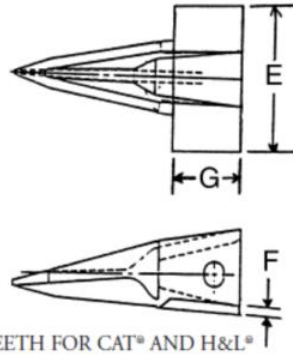

FLYING TIGER® AND WING TIP STYLE TEETH FOR CAT® AND H&L® (Patented)

Part #	Family	Weight lbs.	A	B	C	D	E	F	G
1U3202FT	J200	3.0	6 1/2		2 3/8	2 1/4	5	3/8	2 3/16
6Y3222FT	J225	5.5	8		3 3/16	2 9/16	5	3/8	2 1/2
1U3252FT	J250	9.0	8		3 15/16	2 7/8	6 1/2	1/2	2 7/8
1U3302FT	J300	12.0	9 1/2		4 1/4	4	7 1/2	5/8	3 1/4
1U3352FT	J350	19.8	11		4 7/16	4 1/8	8 7/16	11/16	4 1/16
7T3402FT	J400	26.5	12 3/8		5 5/16	4 7/8	9 3/8	13/16	4
1U3452FT	J450	28.7	13 5/16		5 5/16	5 3/16	10 1/2	7/8	5 1/2
1U3552FT	J550	54.2	15 1/8		6 3/8	6 5/16	14	1 1/16	6 3/8
23W	Long	3.2	5 3/4	1 15/16	1 9/16	1 11/16	4 7/8	3/8	2 3/16
23FT	Tiger	3.1	6 11/16		1 9/16	1 11/16	4 7/8	3/8	2 3/16

SEE CAT® (pages 3 & 4) and H & L® (page 17) for A, B, C, & D measurements.

PLOW BOLTS & NUTS

Item #	Description	Weight lbs.
4F3649	1/2" x 2" Plow Bolt	0.15
4F3662	1/2" x 3" Plow Bolt	0.19
1D4719	1/2" Hex Nut	0.04

4F3664	5/8" x 1 1/2" Plow Bolt	0.16
4F3653	5/8" x 1 3/4" Plow Bolt	0.18
4F3654	5/8" x 2" Plow Bolt	0.20
3F5108	5/8" x 2 1/4" Plow Bolt	0.22
4F3656	5/8" x 2 1/2" Plow Bolt	0.24
4F3657	5/8" x 2 3/4" Plow Bolt	0.27
4F3658	5/8" x 3" Plow Bolt	0.29
4F3665	5/8" x 3 1/2" Plow Bolt	0.33
4F0391	5/8" x 3 3/4" Plow Bolt	0.35
4F3671	5/8" x 4" Plow Bolt	0.37
4K0367	5/8" Hex Nut	0.07

4F3672	3/4" x 2" Plow Bolt	0.30
4F7827	3/4" x 2 1/4" Plow Bolt	0.33
5J4773	3/4" x 2 1/2" Plow Bolt	0.35
5J4771	3/4" x 2 3/4" Plow Bolt	0.39
4F0138	3/4" x 3" Plow Bolt	0.42
1J6762	3/4" x 3 1/4" Plow Bolt	0.42
5F8933	3/4" x 3 3/4" Plow Bolt	0.51
1J0962	3/4" x 4 1/4" Plow Bolt	0.55
4F0253	3/4" x 4 1/2" Plow Bolt	0.61
2J3506	3/4" Hex Nut	0.12

Item #	Description	Weight lbs.
5J4772	7/8" x 2 1/2" Plow Bolt	0.49
6F0196	7/8" x 2 3/4" Plow Bolt	0.53
5J2409	7/8" x 3" Plow Bolt	0.56
2J2548	7/8" x 3 1/2" Plow Bolt	0.66
2J5458	7/8" x 4 1/4" Plow Bolt	0.79
1J0849	7/8" x 4 5/8" Plow Bolt	0.86
2J3505	7/8" Hex Nut	0.18

3J2801	1" x 2 1/2" Plow Bolt	0.60
1J5607	1" x 2 3/4" Plow Bolt	0.71
4F4042	1" x 3" Plow Bolt	0.78
4J9058	1" x 3 1/4" Plow Bolt	0.84
4J9208	1" x 3 1/2" Plow Bolt	0.89
8J2928	1" x 3 3/4" Plow Bolt	0.94
5P8136	1" x 4" Plow Bolt	0.98
1J3527	1" x 4 1/2" Plow Bolt	1.10
2J3507	1" Hex Nut	0.27
8J2933	1" Taper Nut	0.30

6V6535	1 1/4" x 3 3/4" Plow Bolt	1.50
5P8823	1 1/4" x 4 1/4" Plow Bolt	1.97
6V8360	1 1/4" x 4 1/2" Plow Bolt	2.17
5P8361	1 1/4" x 5" Plow Bolt	2.36
3K9770	1 1/4" Hex Nut	0.53
5P8362	1 1/4" Taper Nut	0.60
8T9079	1 1/4" x 3 1/4" Plow Bolt	1.40

